

Models

1800 RPM Models

NTQPM-01-0418 4HP, 220-240 VAC

NTQPM-05-0418 4HP, 440-480 VAC

NTQPM-09-0418 4HP, 550-600 VAC

2400 RPM Models

NTQPM-02-0420 4HP, 220-240 VAC

NTQPM-06-0420 4HP, 440-480 VAC

NTQPM-05-0420 4HP, 550-600 VAC

Key Features

- 30% to 50% reduction in wasted energy
- 4% to 20% reduction in energy usage
- Rapid payback – typically less than 18 months
- Exceeds NEMA Premium & IE3/IE4 efficiency standards
- Maintains high efficiency under partial load
- Superior low speed torque
- Standard NEMA frame sizes for easy substitution
- UL listed

NovaTorque, Inc.

3501 Gateway Blvd.

Fremont, CA 94538

Tel: +1 (510) 933-2700

Fax: +1 (510) 933-2763

Email: info@novatorque.com

www.novatorque.com



NovaTorque 4HP PremiumPlus+® Motors

Electronically Commutated Permanent Magnet (ECPM) Motors

NovaTorque motors are Electronically Commutated Permanent Magnet (ECPM) motors, also referred to as PMAC (Permanent Magnet AC) Motors, designed for variable speed applications. Like all PM motors they are inherently more efficient than induction motors, and that efficiency advantage expands under partial load. Unlike conventional PM motors, NovaTorque's unique patented rotor and stator geometry focuses magnetic flux, allowing the use of low cost ferrite, versus rare earth, magnets. Hence NovaTorque motors are priced to provide extraordinarily rapid payback on the initial investment.

4HP Fan Application - 1800 RPM Motor

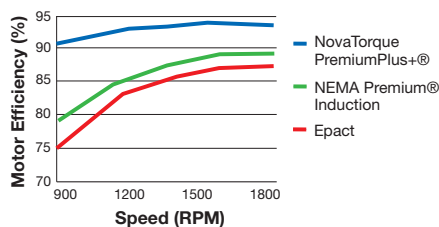

4HP Fan Application - 2400 RPM Motor

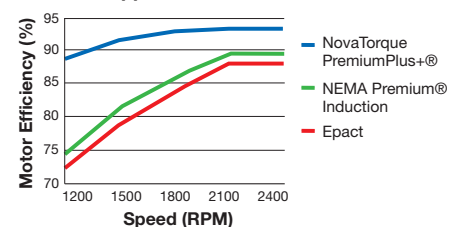

4HP Torque vs. Speed - 1800 RPM Motor

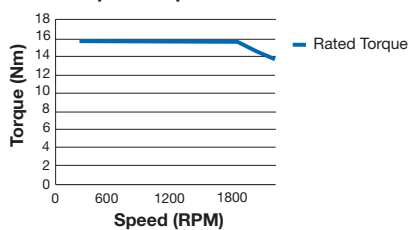

4HP Torque vs. Speed - 2400 RPM Motor

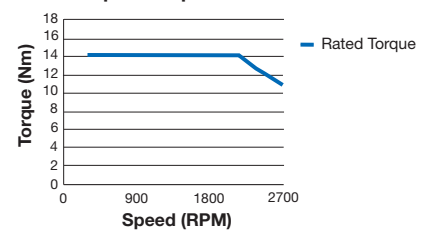

4HP PremiumPlus+[®] Motors

Compatible Variable Frequency Drives (VFDs)

Like all permanent magnet motors, NovaTorque motors require a VFD to operate. Virtually all leading manufacturers of VFDs produce versions capable of sensorless control of PM motors. Consult NovaTorque Applications Engineering for compatible models and parameters.

Specifications

Model	4HP 1800 RPM			4HP 2400 RPM		
	NTQPM-01-0418	NTQPM-05-0418	NTQPM-09-0418	NTQPM-02-0420	NTQPM-06-0420	NTQPM-05-0420
Rated Power (HP)	4.0	4.0	4.0	4.0	4.0	4.0
Phases	3-Phase	3-Phase	3-Phase	3-Phase	3-Phase	3-Phase
Drive Supply Voltage	220-240 VAC	440-480 VAC	550-600 VAC	220-240 VAC	440-480 VAC	550-600 VAC
Rated Full Load Amps	9.4	4.7	3.6	10.8	5.4	4.2
Rated Efficiency	92.5	92.5	92.5	92.5	92.5	92.5
Rated Torque (Nm)	15.8	15.8	15.8	14.2	14.2	14.2
Rated Speed (RPM)	1800	1800	1800	2000	2000	2000
Rated Frequency (Hz)	120	120	120	133	133	133
Maximum Speed (RPM)	2050	2050	2050	2700	2700	2700
Service Factor	1.15	1.15	1.15	1.15	1.15	1.15
Frame Size	182T/184T	182T/184T	182T/184T	182T/184T	182T/184T	182T/184T
Enclosure	TEAO/TEFC	TEAO/TEFC	TEAO/TEFC	TEAO/TEFC	TEAO/TEFC	TEAO/TEFC
Weight	72 lbs	72 lbs	72 lbs	72 lbs	72 lbs	72 lbs
Maximum Winding Temperature	130 deg C	130 deg C	130 deg C	130 deg C	130 deg C	130 deg C
Insulation Grade	Class F	Class F	Class F	Class F	Class F	Class F
Ambient Temperature Rating	-10 to 40 deg C	-10 to 40 deg C	-10 to 40 deg C	-10 to 40 deg C	-10 to 40 deg C	-10 to 40 deg C
Ingress Protection	IP 40 Standard IP 54 Optional	IP 40 Standard IP 54 Optional	IP 40 Standard IP 54 Optional	IP 40 Standard IP 54 Optional	IP 40 Standard IP 54 Optional	IP 40 Standard IP 54 Optional

Dimensions

4HP 182T/184T

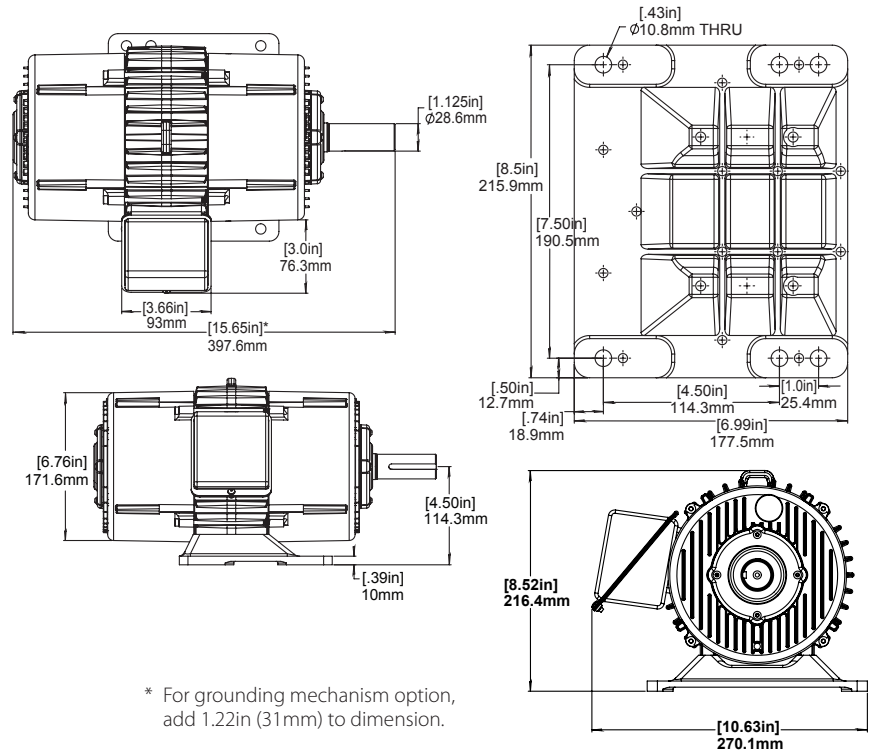

For more information, visit the NovaTorque website, www.novatorque.com